



IMPORTANT NOTICE

10 December 2015

1. Global joint venture starts operations as WeEn Semiconductors

Dear customer,

As from November 9th, 2015 NXP Semiconductors N.V. and Beijing JianGuang Asset Management Co. Ltd established Bipolar Power joint venture (JV), **WeEn Semiconductors**, which will be used in future Bipolar Power documents together with new contact details.

In this document where the previous NXP references remain, please use the new links as shown below.

WWW - For www.nxp.com use www.ween-semi.com

Email - For salesaddresses@nxp.com use salesaddresses@ween-semi.com

For the copyright notice at the bottom of each page (or elsewhere in the document, depending on the version) “© **NXP Semiconductors N.V. {year}. All rights reserved**” becomes “© **WeEn Semiconductors Co., Ltd. {year}. All rights reserved**”

If you have any questions related to this document, please contact our nearest sales office via e-mail or phone (details via salesaddresses@ween-semi.com).

Thank you for your cooperation and understanding,

WeEn Semiconductors





ACTT16B-800CTN

Enhanced and high temperature ACTT power switch

27 July 2015

Product data sheet

1. General description

AC Thyristor Triac power switch in a SOT404 (D2PAK) surface mountable plastic package with self-protective clamping capabilities against low and high energy transients. This "series CTN" triac will commute the full RMS current at the maximum rated junction temperature ($T_{j(max)} = 150\text{ °C}$) without the aid of a snubber. It is used in applications where "high junction operating temperature capability" is required.

2. Features and benefits

- Clamping structure ensuring safe high over-voltage withstand capability
- High junction operating temperature capability ($T_{j(max)} = 150\text{ °C}$)
- High minimum IGT for guaranteed immunity to gate noise
- Full cycle AC conduction
- Over-voltage withstand capability to IEC 61000-4-5
- Pin compatible with standard triacs
- Planar passivated for voltage ruggedness and reliability
- Protective self turn-on capability for high energy transients
- Safe clamping capability for low energy over-voltage transients
- Less sensitive gate for high noise immunity
- Surface mountable package
- Triggering in three quadrants only
- Very high immunity to false turn-on by dV/dt and IEC 61000-4-4 fast transient
- Package meets UL94V0 flammability requirement
- Package is RoHS compliant

3. Applications

- AC fan, pump and compressor controls
- Highly inductive, resistive and safety loads
- Large and small appliances (White Goods)
- Reversing induction motor controls
- Applications subject to high temperature ($T_{j(max)} = 150\text{ °C}$)

4. Quick reference data

Table 1. Quick reference data

Symbol	Parameter	Conditions	Min	Typ	Max	Unit
V_{DRM}	repetitive peak off-state voltage		-	-	800	V



Enhanced and high temperature ACTT power switch

Symbol	Parameter	Conditions	Min	Typ	Max	Unit
$I_{T(RMS)}$	RMS on-state current	full sine wave; $T_{mb} \leq 120\text{ }^{\circ}\text{C}$; Fig. 1 ; Fig. 2 ; Fig. 3	-	-	16	A
I_{TSM}	non-repetitive peak on-state current	full sine wave; $T_{j(init)} = 25\text{ }^{\circ}\text{C}$; $t_p = 20\text{ ms}$; Fig. 4 ; Fig. 5	-	-	140	A
		full sine wave; $T_{j(init)} = 25\text{ }^{\circ}\text{C}$; $t_p = 16.7\text{ ms}$	-	-	150	A
T_j	junction temperature		-	-	150	$^{\circ}\text{C}$
V_{PP}	peak pulse voltage	$T_j = 25\text{ }^{\circ}\text{C}$; non-repetitive, off-state; Fig. 6	-	-	2	kV
Static characteristics						
I_{GT}	gate trigger current	$V_D = 12\text{ V}$; $I_T = 100\text{ mA}$; LD+ G+; $T_j = 25\text{ }^{\circ}\text{C}$; Fig. 8	5	-	35	mA
		$V_D = 12\text{ V}$; $I_T = 100\text{ mA}$; LD+ G-; $T_j = 25\text{ }^{\circ}\text{C}$; Fig. 8	5	-	35	mA
		$V_D = 12\text{ V}$; $I_T = 100\text{ mA}$; LD- G-; $T_j = 25\text{ }^{\circ}\text{C}$; Fig. 8	5	-	35	mA
I_H	holding current	$V_D = 12\text{ V}$; $T_j = 25\text{ }^{\circ}\text{C}$; Fig. 10	-	-	30	mA
V_T	on-state voltage	$I_T = 20\text{ A}$; $T_j = 25\text{ }^{\circ}\text{C}$; Fig. 11	-	-	1.5	V
V_{CL}	clamping voltage	$I_{CL} = 0.1\text{ mA}$; $t_p = 1\text{ ms}$; $T_j = 25\text{ }^{\circ}\text{C}$	850	-	-	V
Dynamic characteristics						
dV_D/dt	rate of rise of off-state voltage	$V_{DM} = 536\text{ V}$; $T_j = 125\text{ }^{\circ}\text{C}$; ($V_{DM} = 67\%$ of V_{DRM}); exponential waveform; gate open circuit	1500	-	-	V/ μs
		$V_{DM} = 536\text{ V}$; $T_j = 150\text{ }^{\circ}\text{C}$; exponential waveform; gate open circuit	1000	-	-	V/ μs
dI_{com}/dt	rate of change of commutating current	$V_D = 400\text{ V}$; $T_j = 150\text{ }^{\circ}\text{C}$; $I_{T(RMS)} = 16\text{ A}$; $dV_{com}/dt = 20\text{ V}/\mu\text{s}$; gate open circuit; snubberless condition	12	-	-	A/ms
		$V_D = 400\text{ V}$; $T_j = 150\text{ }^{\circ}\text{C}$; $I_{T(RMS)} = 16\text{ A}$; $dV_{com}/dt = 10\text{ V}/\mu\text{s}$; gate open circuit	15	-	-	A/ms
		$V_D = 400\text{ V}$; $T_j = 150\text{ }^{\circ}\text{C}$; $I_{T(RMS)} = 16\text{ A}$; $dV_{com}/dt = 1\text{ V}/\mu\text{s}$; gate open circuit	20	-	-	A/ms

5. Pinning information

Table 2. Pinning information

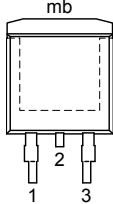
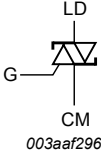
Pin	Symbol	Description	Simplified outline	Graphic symbol
1	CM	common	 <p>D2PAK (SOT404A)</p>	 <p>003aaf296</p>
2	LD	load		
3	G	gate		
mb	LD	mounting base; load		

6. Ordering information

Table 3. Ordering information

Type number	Package		
	Name	Description	Version
ACTT16B-800CTN	D2PAK	plastic single-ended surface-mounted package (D2PAK); 3 leads (one lead cropped)	SOT404A

7. Marking

Table 4. Marking codes

Type number	Marking code
ACTT16B-800CTN	ACTT16B-800CTN

8. Limiting values

Table 5. Limiting values

In accordance with the Absolute Maximum Rating System (IEC 60134).

Symbol	Parameter	Conditions	Min	Max	Unit
V_{DRM}	repetitive peak off-state voltage		-	800	V
$I_{T(RMS)}$	RMS on-state current	full sine wave; $T_{mb} \leq 120\text{ }^{\circ}\text{C}$; Fig. 1 ; Fig. 2 ; Fig. 3	-	16	A
I_{TSM}	non-repetitive peak on-state current	full sine wave; $T_{j(\text{init})} = 25\text{ }^{\circ}\text{C}$; $t_p = 20\text{ ms}$; Fig. 4 ; Fig. 5	-	140	A
		full sine wave; $T_{j(\text{init})} = 25\text{ }^{\circ}\text{C}$; $t_p = 16.7\text{ ms}$	-	150	A
I^2t	I^2t for fusing	$t_p = 10\text{ ms}$; sine-wave pulse	-	98	A ² s
dl_T/dt	rate of rise of on-state current	$I_G = 70\text{ mA}$	-	100	A/ μs
I_{GM}	peak gate current	$t = 20\text{ }\mu\text{s}$	-	2	A
P_{GM}	peak gate power		-	5	W
$P_{G(AV)}$	average gate power	over any 20 ms period	-	0.5	W
T_{stg}	storage temperature		-40	150	$^{\circ}\text{C}$
T_j	junction temperature		-	150	$^{\circ}\text{C}$
V_{PP}	peak pulse voltage	$T_j = 25\text{ }^{\circ}\text{C}$; non-repetitive, off-state; Fig. 6	-	2	kV

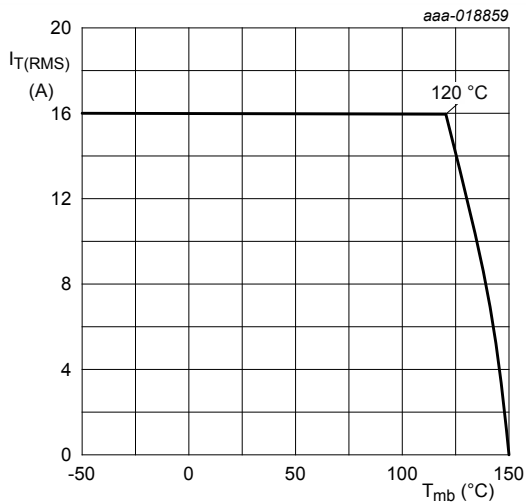
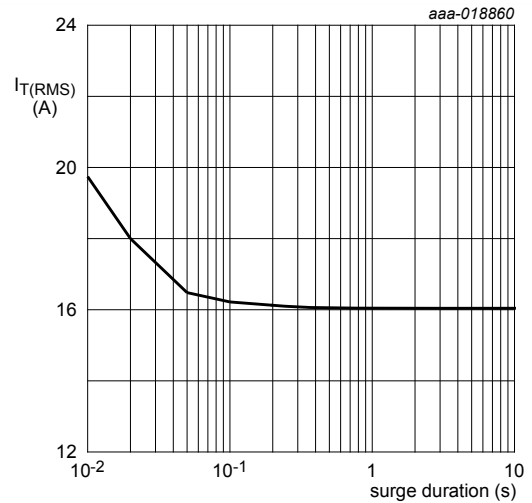

Fig. 1. RMS on-state current as a function of mounting base temperature; maximum values



$f = 50\text{ Hz}$; $T_{mb} = 120\text{ }^{\circ}\text{C}$

Fig. 2. RMS on-state current as a function of surge duration; maximum values

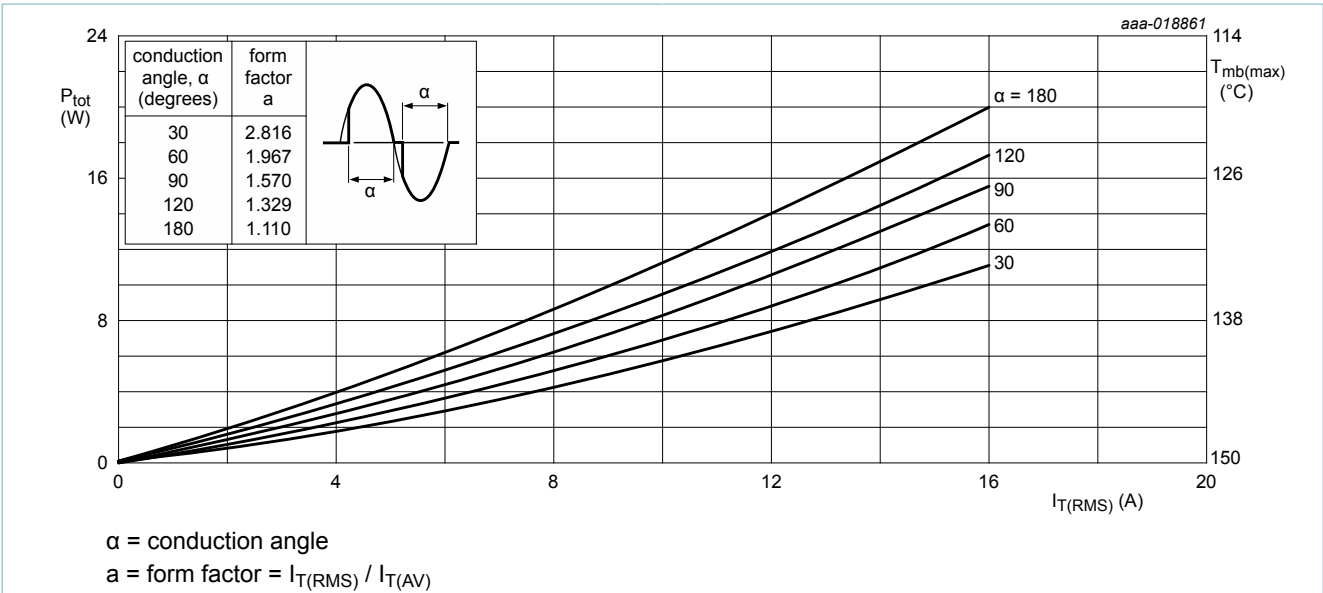

Fig. 3. Total power dissipation as a function of RMS on-state current; maximum values

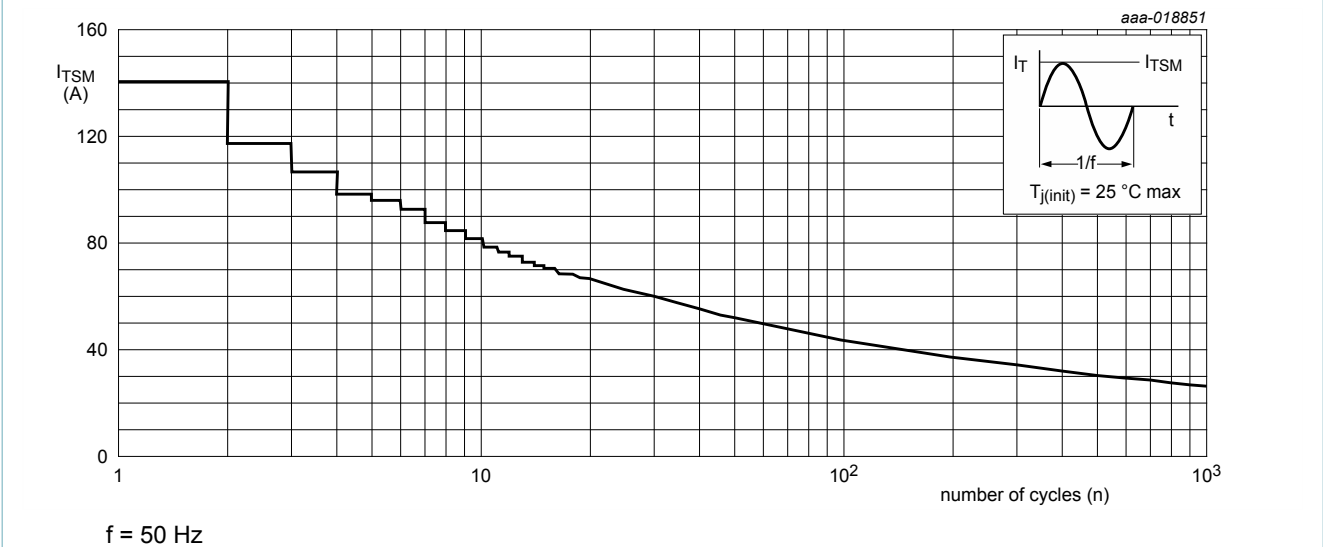

Fig. 4. Non-repetitive peak on-state current as a function of the number of sinusoidal current cycles; maximum values

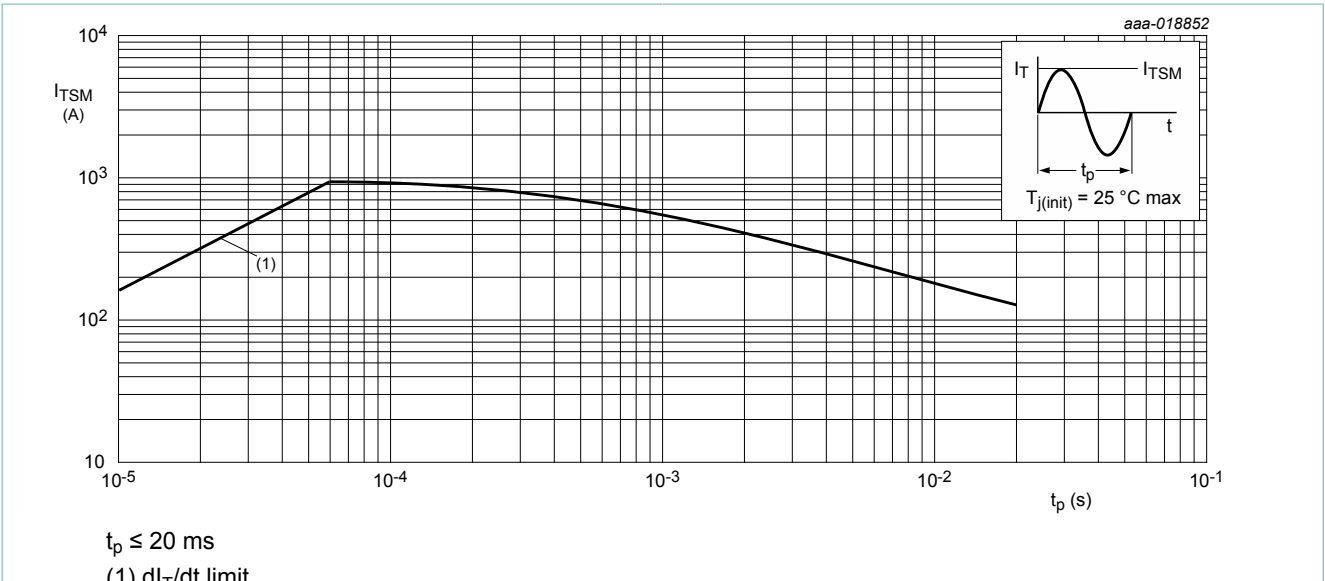

Fig. 5. Non-repetitive peak on-state current as a function of pulse width; maximum values

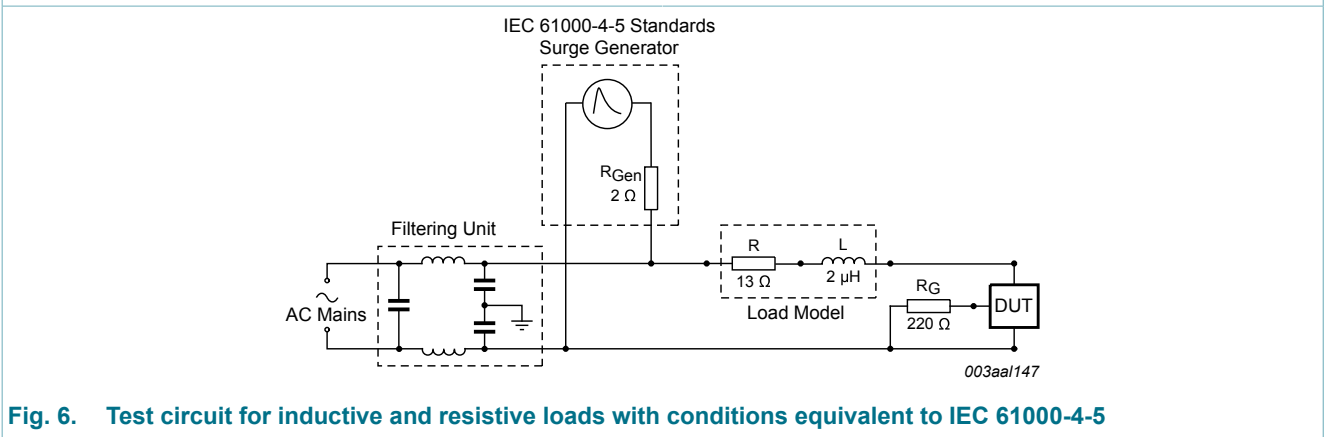

Fig. 6. Test circuit for inductive and resistive loads with conditions equivalent to IEC 61000-4-5

9. Thermal characteristics

Table 6. Thermal characteristics

Symbol	Parameter	Conditions	Min	Typ	Max	Unit
$R_{th(j-mb)}$	thermal resistance from junction to mounting base	full cycle; Fig. 7	-	-	1.5	K/W
		half cycle	-	-	2	K/W
$R_{th(j-a)}$	thermal resistance from junction to ambient free air	in free air; printed circuit board (FR4) mounted	-	55	-	K/W

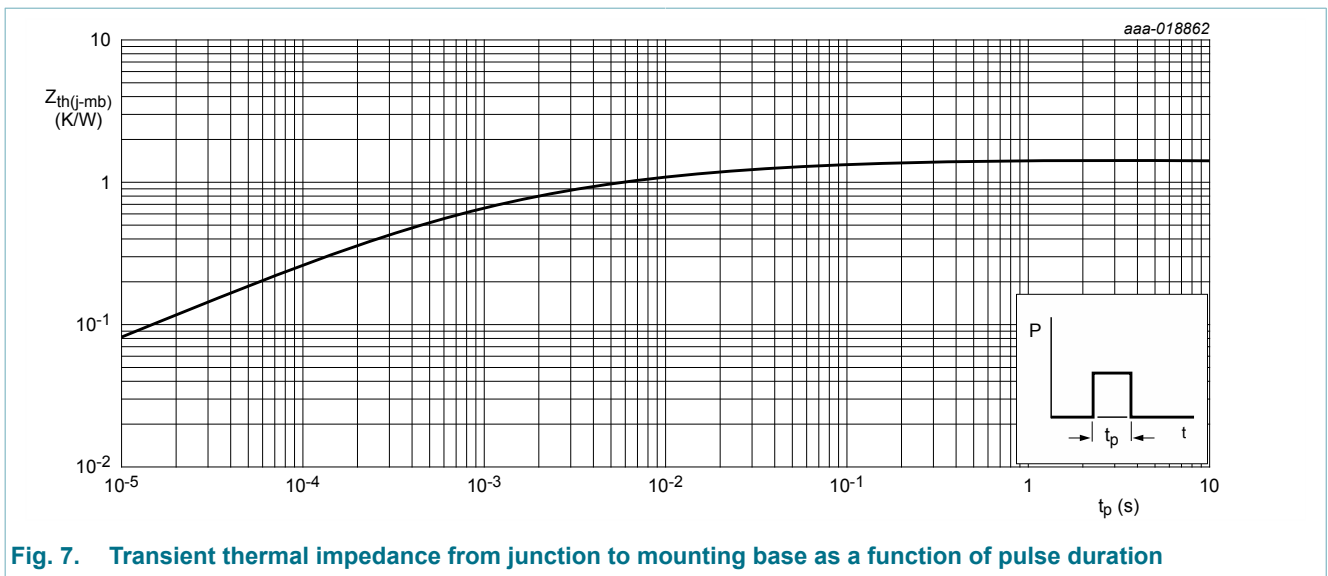

Fig. 7. Transient thermal impedance from junction to mounting base as a function of pulse duration

10. Characteristics

Table 7. Characteristics

Symbol	Parameter	Conditions	Min	Typ	Max	Unit
Static characteristics						
I _{GT}	gate trigger current	V _D = 12 V; I _T = 100 mA; LD+ G+; T _j = 25 °C; Fig. 8	5	-	35	mA
		V _D = 12 V; I _T = 100 mA; LD+ G-; T _j = 25 °C; Fig. 8	5	-	35	mA
		V _D = 12 V; I _T = 100 mA; LD- G-; T _j = 25 °C; Fig. 8	5	-	35	mA
I _L	latching current	V _D = 12 V; I _G = 100 mA; LD+ G+; T _j = 25 °C; Fig. 9	-	-	40	mA
		V _D = 12 V; I _G = 100 mA; LD+ G-; T _j = 25 °C; Fig. 9	-	-	50	mA
		V _D = 12 V; I _G = 100 mA; LD- G-; T _j = 25 °C; Fig. 9	-	-	40	mA
I _H	holding current	V _D = 12 V; T _j = 25 °C; Fig. 10	-	-	30	mA
V _T	on-state voltage	I _T = 20 A; T _j = 25 °C; Fig. 11	-	-	1.5	V
V _{GT}	gate trigger voltage	V _D = 12 V; I _T = 100 mA; T _j = 25 °C; Fig. 12	-	0.8	1	V
		V _D = 400 V; I _T = 100 mA; T _j = 150 °C; Fig. 12	0.2	0.45	-	V
I _D	off-state current	V _D = 800 V; T _j = 25 °C	-	-	10	μA
		V _D = 800 V; T _j = 150 °C	-	-	2	mA
V _{CL}	clamping voltage	I _{CL} = 0.1 mA; t _p = 1 ms; T _j = 25 °C	850	-	-	V
Dynamic characteristics						
dV _D /dt	rate of rise of off-state voltage	V _{DM} = 536 V; T _j = 125 °C; (V _{DM} = 67% of V _{DRM}); exponential waveform; gate open circuit	1500	-	-	V/μs
		V _{DM} = 536 V; T _j = 150 °C; exponential waveform; gate open circuit	1000	-	-	V/μs
dI _{com} /dt	rate of change of commutating current	V _D = 400 V; T _j = 150 °C; I _{T(RMS)} = 16 A; dV _{com} /dt = 20 V/μs; gate open circuit; snubberless condition	12	-	-	A/ms
		V _D = 400 V; T _j = 150 °C; I _{T(RMS)} = 16 A; dV _{com} /dt = 10 V/μs; gate open circuit	15	-	-	A/ms
		V _D = 400 V; T _j = 150 °C; I _{T(RMS)} = 16 A; dV _{com} /dt = 1 V/μs; gate open circuit	20	-	-	A/ms

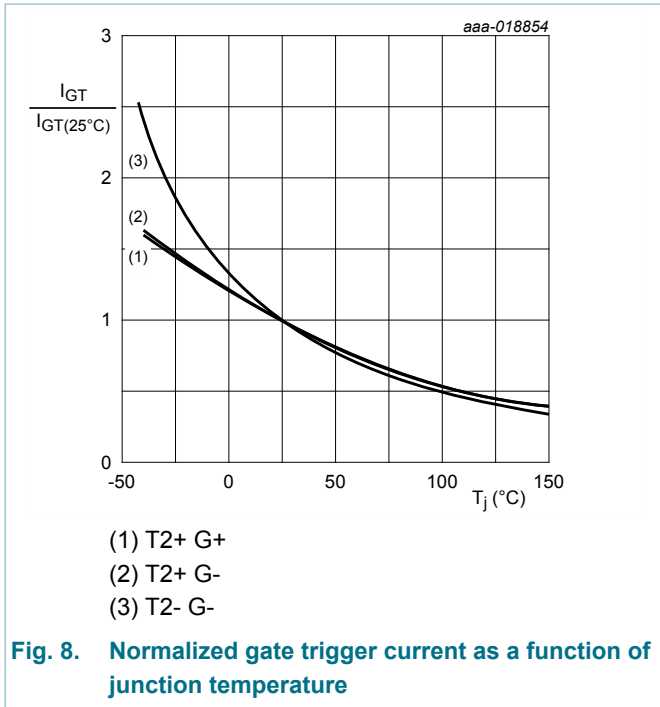

Fig. 8. Normalized gate trigger current as a function of junction temperature

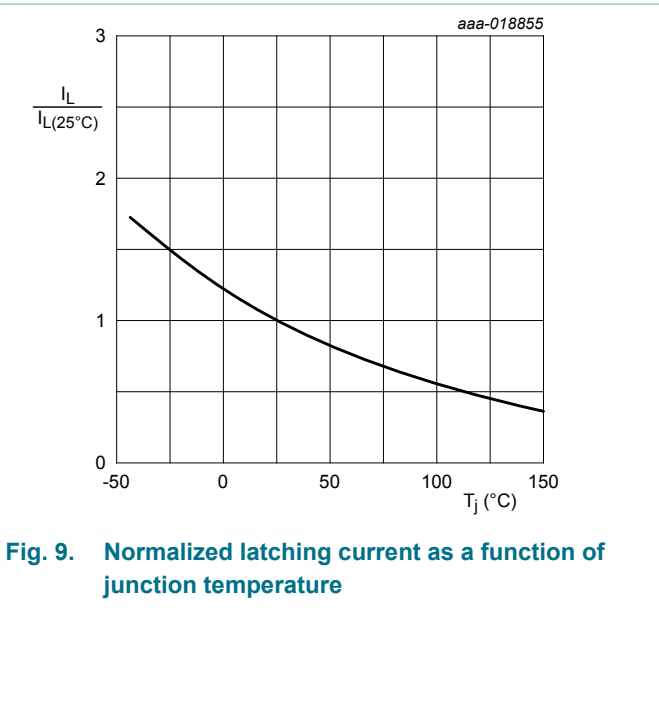

Fig. 9. Normalized latching current as a function of junction temperature

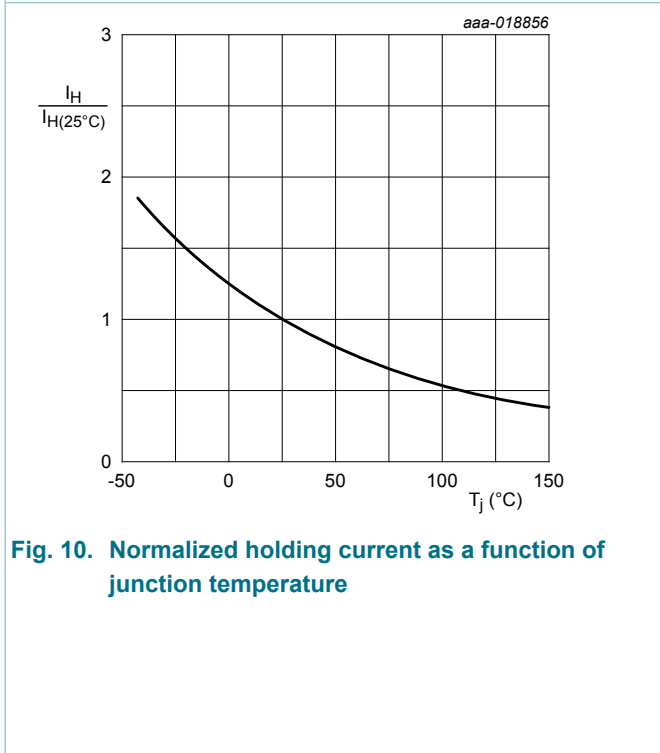

Fig. 10. Normalized holding current as a function of junction temperature

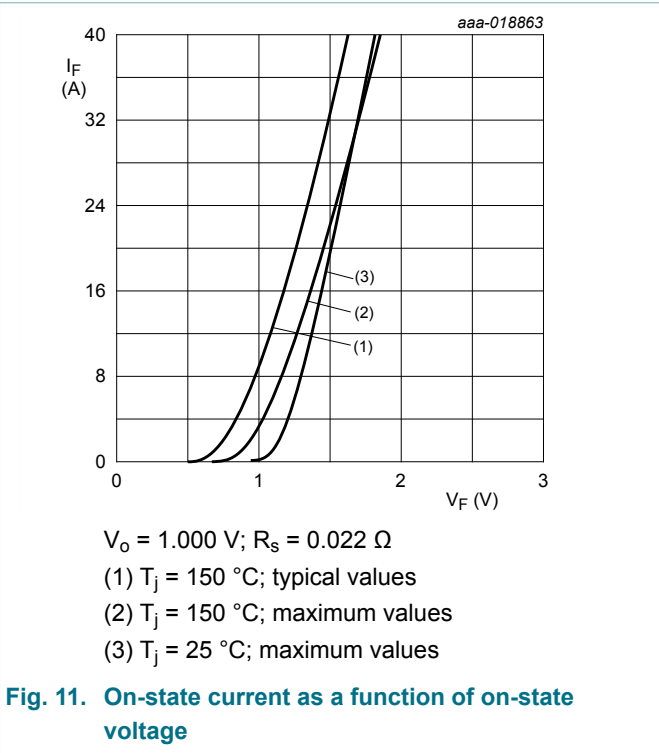

Fig. 11. On-state current as a function of on-state voltage

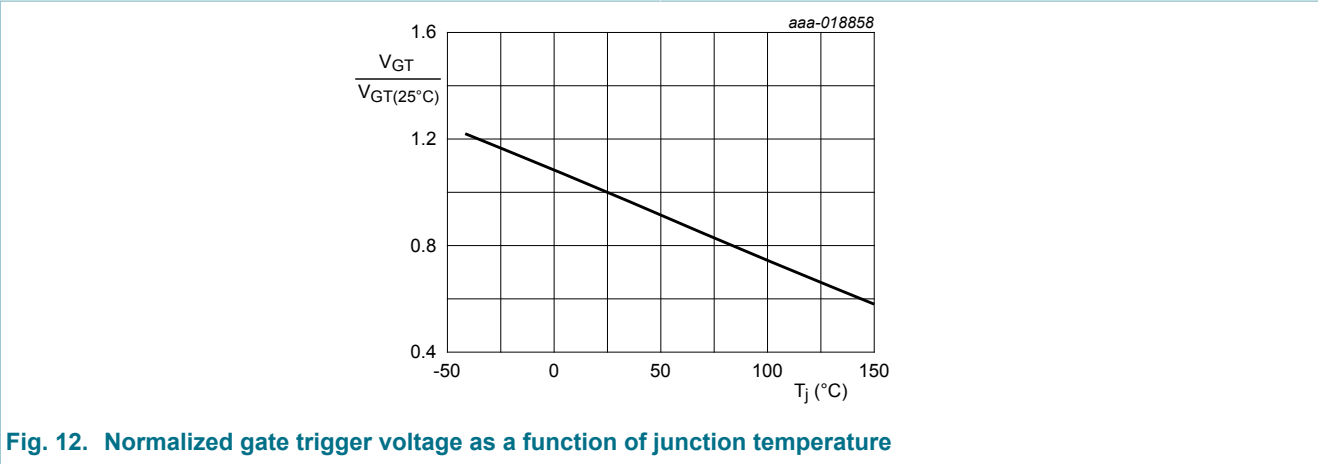
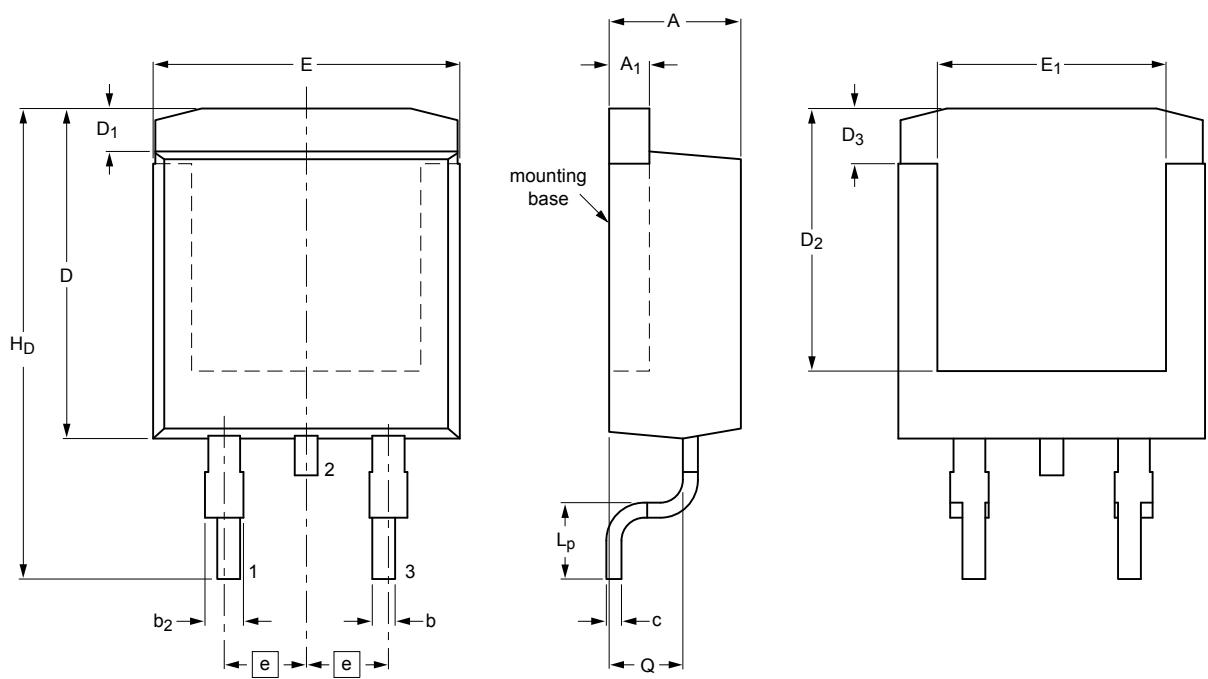

Fig. 12. Normalized gate trigger voltage as a function of junction temperature

11. Package outline

Plastic single-ended surface-mounted package (D2PAK); 3 leads (one lead cropped) SOT404A



Dimensions (mm are the original dimensions)

Unit	A	A ₁	b	b ₂	c	D _{max}	D ₁	D ₂	D ₃	E	E ₁	e	H _D	L _p	Q
max	4.5	1.40	0.85	1.45	0.64	11	1.6	8.6	1.85	10.3	8.1		15.8	2.9	2.6
nom												2.54			
min	4.1	1.27	0.60	1.05	0.46		1.2	8.0	1.40	9.7	7.6		14.8	2.1	2.2

sot404a_po

Outline version	References				European projection	Issue date
	IEC	JEDEC	JEITA			
SOT404A						13-02-28 13-03-12

Fig. 13. Package outline D2PAK (SOT404A)

12. Legal information

12.1 Data sheet status

Document status [1][2]	Product status [3]	Definition
Objective [short] data sheet	Development	This document contains data from the objective specification for product development.
Preliminary [short] data sheet	Qualification	This document contains data from the preliminary specification.
Product [short] data sheet	Production	This document contains the product specification.

- [1] Please consult the most recently issued document before initiating or completing a design.
- [2] The term 'short data sheet' is explained in section "Definitions".
- [3] The product status of device(s) described in this document may have changed since this document was published and may differ in case of multiple devices. The latest product status information is available on the Internet at URL <http://www.nxp.com>.

12.2 Definitions

Preview — The document is a preview version only. The document is still subject to formal approval, which may result in modifications or additions. NXP Semiconductors does not give any representations or warranties as to the accuracy or completeness of information included herein and shall have no liability for the consequences of use of such information.

Draft — The document is a draft version only. The content is still under internal review and subject to formal approval, which may result in modifications or additions. NXP Semiconductors does not give any representations or warranties as to the accuracy or completeness of information included herein and shall have no liability for the consequences of use of such information.

Short data sheet — A short data sheet is an extract from a full data sheet with the same product type number(s) and title. A short data sheet is intended for quick reference only and should not be relied upon to contain detailed and full information. For detailed and full information see the relevant full data sheet, which is available on request via the local NXP Semiconductors sales office. In case of any inconsistency or conflict with the short data sheet, the full data sheet shall prevail.

Product specification — The information and data provided in a Product data sheet shall define the specification of the product as agreed between NXP Semiconductors and its customer, unless NXP Semiconductors and customer have explicitly agreed otherwise in writing. In no event however, shall an agreement be valid in which the NXP Semiconductors product is deemed to offer functions and qualities beyond those described in the Product data sheet.

12.3 Disclaimers

Limited warranty and liability — Information in this document is believed to be accurate and reliable. However, NXP Semiconductors does not give any representations or warranties, expressed or implied, as to the accuracy or completeness of such information and shall have no liability for the consequences of use of such information. NXP Semiconductors takes no responsibility for the content in this document if provided by an information source outside of NXP Semiconductors.

In no event shall NXP Semiconductors be liable for any indirect, incidental, punitive, special or consequential damages (including - without limitation - lost profits, lost savings, business interruption, costs related to the removal or replacement of any products or rework charges) whether or not such damages are based on tort (including negligence), warranty, breach of contract or any other legal theory.

Notwithstanding any damages that customer might incur for any reason whatsoever, NXP Semiconductors' aggregate and cumulative liability towards customer for the products described herein shall be limited in accordance with the *Terms and conditions of commercial sale* of NXP Semiconductors.

Right to make changes — NXP Semiconductors reserves the right to make changes to information published in this document, including without limitation specifications and product descriptions, at any time and without notice. This document supersedes and replaces all information supplied prior to the publication hereof.

Suitability for use — NXP Semiconductors products are not designed, authorized or warranted to be suitable for use in life support, life-critical or safety-critical systems or equipment, nor in applications where failure or malfunction of an NXP Semiconductors product can reasonably be expected to result in personal injury, death or severe property or environmental damage. NXP Semiconductors and its suppliers accept no liability for inclusion and/or use of NXP Semiconductors products in such equipment or applications and therefore such inclusion and/or use is at the customer's own risk.

Quick reference data — The Quick reference data is an extract of the product data given in the Limiting values and Characteristics sections of this document, and as such is not complete, exhaustive or legally binding.

Applications — Applications that are described herein for any of these products are for illustrative purposes only. NXP Semiconductors makes no representation or warranty that such applications will be suitable for the specified use without further testing or modification.

Customers are responsible for the design and operation of their applications and products using NXP Semiconductors products, and NXP Semiconductors accepts no liability for any assistance with applications or customer product design. It is customer's sole responsibility to determine whether the NXP Semiconductors product is suitable and fit for the customer's applications and products planned, as well as for the planned application and use of customer's third party customer(s). Customers should provide appropriate design and operating safeguards to minimize the risks associated with their applications and products.

NXP Semiconductors does not accept any liability related to any default, damage, costs or problem which is based on any weakness or default in the customer's applications or products, or the application or use by customer's third party customer(s). Customer is responsible for doing all necessary testing for the customer's applications and products using NXP Semiconductors products in order to avoid a default of the applications and the products or of the application or use by customer's third party customer(s). NXP does not accept any liability in this respect.

Limiting values — Stress above one or more limiting values (as defined in the Absolute Maximum Ratings System of IEC 60134) will cause permanent damage to the device. Limiting values are stress ratings only and (proper) operation of the device at these or any other conditions above those given in the Recommended operating conditions section (if present) or the Characteristics sections of this document is not warranted. Constant or repeated exposure to limiting values will permanently and irreversibly affect the quality and reliability of the device.

Terms and conditions of commercial sale — NXP Semiconductors products are sold subject to the general terms and conditions of commercial sale, as published at <http://www.nxp.com/profile/terms>, unless otherwise agreed in a valid written individual agreement. In case an individual agreement is concluded only the terms and conditions of the respective agreement shall apply. NXP Semiconductors hereby expressly objects to applying the customer's general terms and conditions with regard to the purchase of NXP Semiconductors products by customer.

No offer to sell or license — Nothing in this document may be interpreted or construed as an offer to sell products that is open for acceptance or the

grant, conveyance or implication of any license under any copyrights, patents or other industrial or intellectual property rights.

Export control — This document as well as the item(s) described herein may be subject to export control regulations. Export might require a prior authorization from competent authorities.

Non-automotive qualified products — Unless this data sheet expressly states that this specific NXP Semiconductors product is automotive qualified, the product is not suitable for automotive use. It is neither qualified nor tested in accordance with automotive testing or application requirements. NXP Semiconductors accepts no liability for inclusion and/or use of non-automotive qualified products in automotive equipment or applications.

In the event that customer uses the product for design-in and use in automotive applications to automotive specifications and standards, customer (a) shall use the product without NXP Semiconductors' warranty of the product for such automotive applications, use and specifications, and (b) whenever customer uses the product for automotive applications beyond NXP Semiconductors' specifications such use shall be solely at customer's own risk, and (c) customer fully indemnifies NXP Semiconductors for any liability, damages or failed product claims resulting from customer design and use of the product for automotive applications beyond NXP Semiconductors' standard warranty and NXP Semiconductors' product specifications.

Translations — A non-English (translated) version of a document is for reference only. The English version shall prevail in case of any discrepancy between the translated and English versions.

12.4 Trademarks

Notice: All referenced brands, product names, service names and trademarks are the property of their respective owners.

Bitsound, CoolFlux, CoReUse, DESFire, FabKey, GreenChip, HiPerSmart, HITAG, I²C-bus logo, ICODE, I-CODE, ITEC, MIFARE, MIFARE Plus, MIFARE Ultralight, SmartXA, STARplug, TOPFET, TrenchMOS, TriMedia and UCODE — are trademarks of NXP Semiconductors N.V.

HD Radio and HD Radio logo — are trademarks of iBiquity Digital Corporation.

13. Contents

1	General description	1
2	Features and benefits	1
3	Applications	1
4	Quick reference data	1
5	Pinning information	3
6	Ordering information	3
7	Marking	3
8	Limiting values	4
9	Thermal characteristics	7
10	Characteristics	8
11	Package outline	11
12	Legal information	12
12.1	Data sheet status	12
12.2	Definitions	12
12.3	Disclaimers	12
12.4	Trademarks	13

© NXP Semiconductors N.V. 2015. All rights reserved

For more information, please visit: <http://www.nxp.com>

For sales office addresses, please send an email to: salesaddresses@nxp.com

Date of release: 27 July 2015